



- IMPEDANCE SHOWN IS CALCULATED VALUE - NOT GUARANTEED
 - SERIAL NUMBER AND TESTED IMPEDANCE WILL BE SHOWN ON TRANSFORMER NAMEPLATE



POWER SOLUTIONS
 Guelph, ONT Compton, CA Baraboo, WI Monterrey, MX

HPS Titan™ N
 Dry Type Encapsulated Transformer
 Transformateur de Type Sec Encapsulé



31GW E258346
 GENERAL PURPOSE TRANSFORMER FOR USE IN HAZARDOUS LOCATIONS
 BUILT TO ABS STANDARD

Cust. Ref. [] Serial No. []
 Ref. du Client [] No. de Serie []

Phase 3 HV/HT 480V 54.1A

Type HZQT BIL 10 kV

Cooling ANC Term Bornes H1 H2 H3

kVA 45 LV/BT 240V 108.3A

Temp. Rise 115 °C
 Echauffement

Temp Class 180 °C
 Classe Temp

Winding CU

Frequency 60

Impedance % 2.1
 @ 135 °C

Encl. Type 4
 Type De Coffrage

Weight lbs/kg 661/300
 Poids

VOLTS	CURRENT COURANT	% RATED VOLTAGE % TENSION NOMINALE	CONNECTION EACH PHASE CONNECTION PAR PHASE	HAZARDOUS LOCATIONS CLASS 1, DIV 2 GROUPS A, B, C & D TEMPERATURE CODE: T3A
504	51.5	105	1	HAZARDOUS LOCATIONS CLASS 1, ZONE 2 GROUPS IIC, T3
480	52.8	102.5	2	SPACINGS BETWEEN ANY VENTILATED ENCLOSURE PANEL AND ANY ADJACENT WALL SHALL BE A MINIMUM OF 3 INCHES ELECTROSTATIC SHIELD
468	54.1	100	3	
456	55.5	97.5	4	
444	57.0	95	5	
432	58.5	92.5	6	
	60.1	90	7	

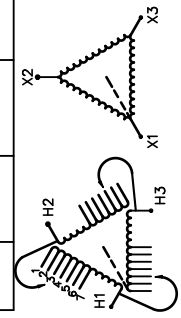

WARNING - EXPLOSION HAZARD. DO NOT DISCONNECT EQUIPMENT WHILE THE CIRCUIT IS LIVE OR UNLESS THE AREA IS FREE OF IGNITABLE CONCENTRATIONS.
 AVERTISSEMENT : RISQUE D'EXPLOSION. NE PAS DÉBRANCHER PENDANT QUE LE CIRCUIT EST SOUS TENSION OU A MOINS QUE L'EMPLACEMENT NE SOIT EXEMPT DE CONCENTRATIONS INFLAMMABLES.

SEISMIC QUALIFICATIONS:
 OSP=0.136/IBC 2018/ASCE 7-16
 SDS<=2.0g Z/h=1 Ip=1.5

d000200bq



TITLE: 3PH DISTRIBUTION TRANSFORMER
 NAMEPLATE INFORMATION

NO.	DATE	BY	REVISION

DES: PGAUETR
 DATE: 22/09/07
 SCALE: NTS

SHEET 1 OF 2

EJB TN2D0045KDKF

FRONT VIEW

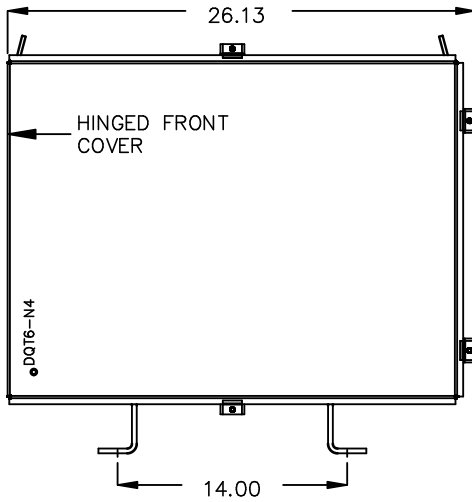

SIDE VIEW

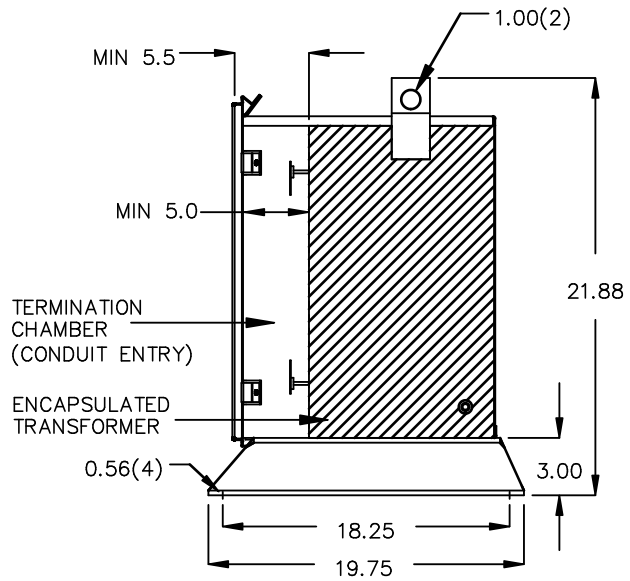

All Dimensions in inches

ENCLOSURE COLOR : ANSI 61 GREY – OUTDOOR

HV TERMINAL DETAIL

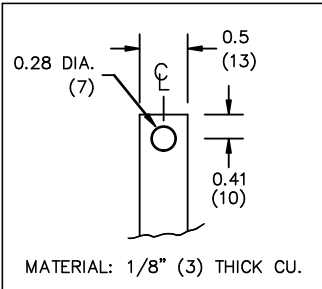

LV TERMINAL DETAIL

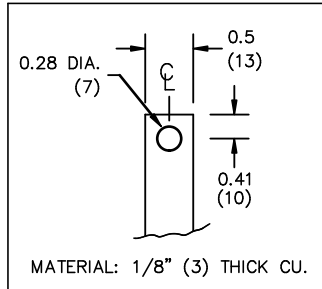

CUSTOMER NOTES:

- HV TERMINATED AT BOTTOM FRONT
- LV TERMINATED AT TOP FRONT



TITLE: 3PH DISTRIBUTION TRANSFORMER

				DES: PGAUETR
				DATE: 22/09/07
NO.	DATE	BY	REVISION	SCALE: NTS

SHEET 2 OF 2

EDB TN2D0045DKF