



TITLE: 3PH DISTRIBUTION TRANSFORMER
NAMEPLATE INFORMATION

1	21/07/16	PP	EDB UPDATE	DES: PPICASSI
NO.	DATE	BY	REVISION	SCALE: NTS

SHEET 1 OF 2

EDB TN2A0045KHKE

1.0 httpd 2026/06/25 03:20

THIS DRAWING CONTAINS STRICTLY CONFIDENTIAL INFORMATION BELONGING TO HAMMOND POWER SOLUTIONS AND MUST NOT BE DISTRIBUTED OUTSIDE AUTHORIZED PARTIES.



POWER SOLUTIONS
Guelph, ONT Compton, CA Baraboo, WI Monterrey, MX

HPS Titan™ N
Dry Type Encapsulated Transformer
Transformateur de Type Sec Encapsulé

Part No. **TN2A0045KHKE**



31GW E258346
GENERAL PURPOSE TRANSFORMER FOR USE IN HAZARDOUS LOCATIONS



8 03423 15121 18

Cust. Ref. Ref. du Client		Serial No. No. de Serie		VOLTS	CONNECTION EACH PHASE CONNECTION PAR PHASE	HAZARDOUS LOCATIONS CLASS 1, DIV 2 GROUPS A, B, C & D TEMPERATURE CODE: T3A
Phase	3	HV/HT	480V	504	1	HAZARDOUS LOCATIONS CLASS 1, ZONE 2 GROUPS IIC, T3
Type	HZQT	BIL	10 kV	492	2	SPACINGS BETWEEN ANY VENTILATED ENCLOSURE PANEL AND ANY ADJACENT WALL SHALL BE A MINIMUM OF 3 INCHES ELECTROSTATIC SHIELD
Cooling Refroidissement	ANC	Term Bornes	H1 H2 H3	480	3	
kVA	45	LV/BT	400Y/231V 65.0A	468	4	
Temp. Rise Echauffement	115 °C	BIL	10 kV	456	5	
Temp Class Classe Temp	180 °C	Term Bornes	X0 X1 X2 X3	444	6	
Winding Enroulement	CU			432	7	
Frequency Hz	60					
Impedance % @ 135 °C	2					
Encl. Type Type de Coffrage	4					
Weight Poids	625					

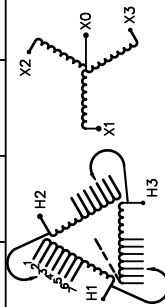

WARNING - EXPLOSION HAZARD. DO NOT DISCONNECT EQUIPMENT WHILE THE CIRCUIT IS LIVE OR UNLESS THE AREA IS FREE OF IGNITABLE CONCENTRATIONS.
AVERTISSEMENT : RISQUE D'EXPLOSION. NE PAS D BRANCHER PENDANT QUE LE CIRCUIT EST SOUS TENSION OU MOINS QUE L'EMPLACEMENT NE SOIT EXEMPT DE CONCENTRATIONS INFLAMMABLES.

SEISMIC QUALIFICATIONS:
OSP=0136/IBC 2018/ASCE 7-16
SDS<=2.0g Z/h=1 p=1.5

d000200bq

FRONT VIEW

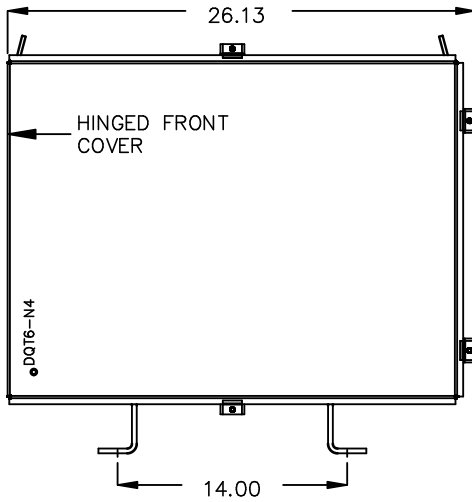

SIDE VIEW

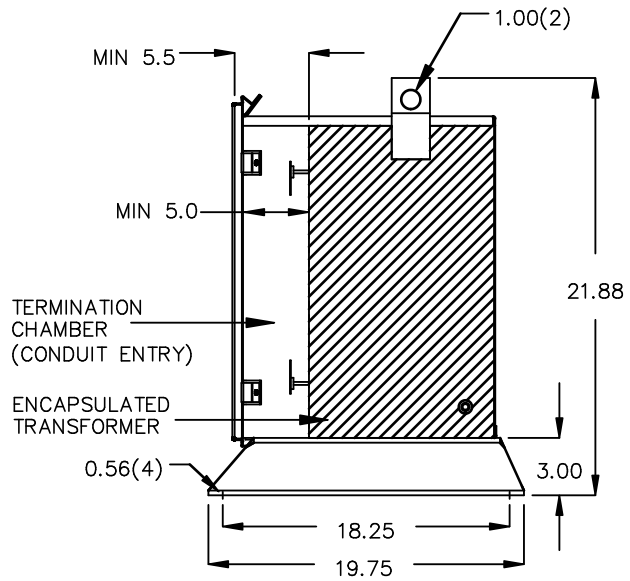

All Dimensions in inches

ENCLOSURE COLOR : ANSI 61 GREY – OUTDOOR

HV TERMINAL DETAIL

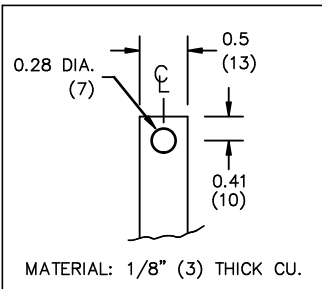

LV TERMINAL DETAIL

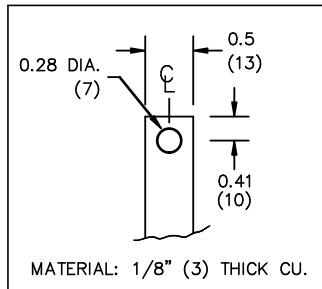

CUSTOMER NOTES:

- HV TERMINATED AT BOTTOM FRONT
- LV TERMINATED AT TOP FRONT



TITLE: 3PH DISTRIBUTION TRANSFORMER

1	21/07/16	PP	EDB UPDATE	DES: PPICASSI
NO.	DATE	BY	REVISION	SCALE: NTS

SHEET 2 OF 2

EDB TN2A0045KHKF