



TITLE: 3PH DISTRIBUTION TRANSFORMER
NAMEPLATE INFORMATION

NO.	DATE	BY	REVISION	DES: PPI/CASSI
				DATE: 18/06/05
				SCALE: NTS

SHEET 1 OF 3

EDBTE3A0660JC

0.0 httpd 2026/04/02 17:15

THIS DRAWING CONTAINS STRICTLY CONFIDENTIAL INFORMATION BELONGING TO HAMMOND POWER SOLUTIONS AND MUST NOT BE DISTRIBUTED OUTSIDE AUTHORIZED PARTIES.



POWER SOLUTIONS
Guelph, ONT Compton, CA Baraboo, WI Monterrey, MX

HPS Tribune™ E
Energy Efficient Drive Isolation Transformer
Transformateur Pour Variateur de Vitesse à Efficacité Énergétique

Part No. **TE3A0660JC**

DRY TYPE TRANSFORMER
77US E112313
ALSO REFER TO STANDARD CRO20-18
BY UNDERWRITERS LABORATORIES INC. 01/18

Serial No. []
No. de Serie []

HV/HT 460V 828A

BIL 10 kV

Term Bornes H1 H2 H3

LV/BT 230Y/133V 1657A

BIL 10 kV

Term Bornes X0 X1 X2 X3

Energy Regulations DOE 10 CFR PART 431:2016

Reglements de l'Energétique CEE ACT SOR/2018-201

Cust. Ref. []
Ref. du Client []

Phase 3

Type K

Cooling Refroidissement ANN

kVA 660

Temp. Rise Echauffement 150 °C

Temp Class Classe Temp 220 °C

Winding Enroulement AL

Frequency Fréquence Hz 60

Impedance % @ 170 °C 5.4

Encl. Type Type de Coffrage 3R

Weight Poids lbs 4000

LISTED



LR 3902



8 03423 174338 1

SPACINGS BETWEEN ANY VENTILATED ENCLOSURE PANEL AND ANY ADJACENT WALL SHALL BE A MINIMUM OF 12 INCHES ELECTROSTATIC SHIELD

VOLTS	CURRENT COURANT	% RATED VOLTAGE % TENSION NOMINALE	CONNECTION EACH PHASE CONNECTION PAR PHASE
483	789	105	1-2
472	808	102.5	2-3
460	828	100	3-4
448	850	97.5	4-5
437	872	95	5-6

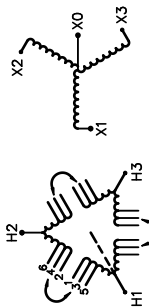

SEISMIC QUALIFICATIONS:
AS FLOOR MOUNT ONLY
IBC 2018/ASCE 7-16
SDS<=2.0g Z/h=0 Ip=1.5

d000194hb

FRONT VIEW

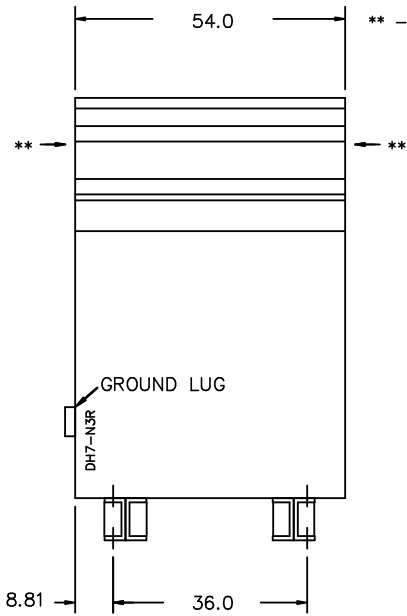

** - Recommended cable entry locations only
cutouts & gland plates not provided.

SIDE VIEW

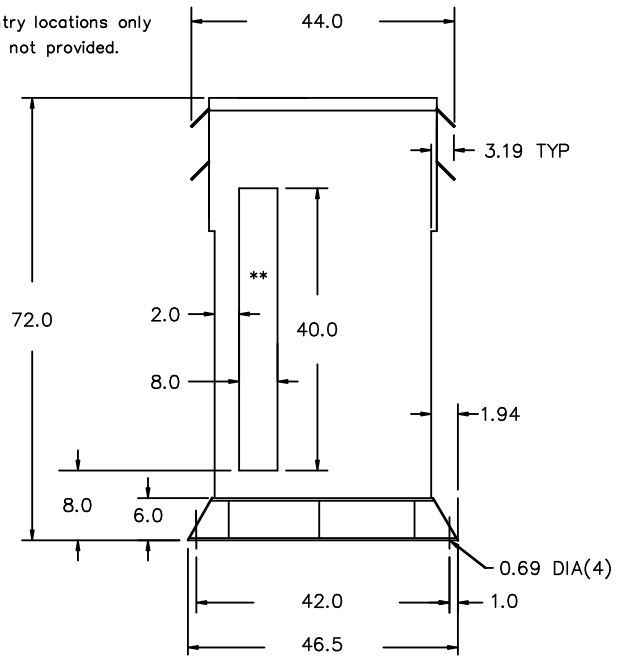

All Dimensions in inches

ENCLOSURE COLOR : ANSI 61 GREY - OUTDOOR

HV TERMINAL DETAIL

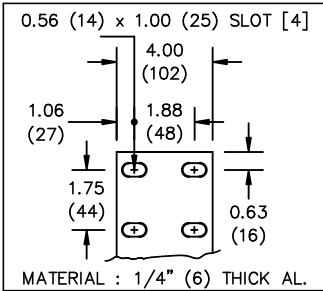

LV TERMINAL DETAIL

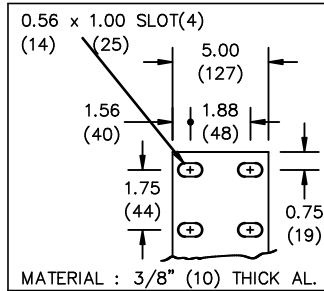

CUSTOMER NOTES:

- HV TERMINATED AT TOP FRONT
- LV TERMINATED AT BOTTOM FRONT
- C/W 1-"NC"- THERMOSTAT PER COIL CONNECTED TO T.B.



TITLE: 3PH DISTRIBUTION TRANSFORMER

DES:	PPICASSI
DATE:	18/06/05
SCALE:	NTS

NO.	DATE	BY	REVISION

SHEET 2 OF 3

EDBTE3A0660JC

ENCLOSURE BOTTOM VIEW



NOTE:
 WHEN BOTTOM CABLE ENTRY IS OPTED, THE SPACE USED FOR CONDUITS IN THE FRONT OF THE TRANSFORMER SHOULD NOT OBSTRUCT MORE THAN 50% OF THE FRONT AIR INTAKE AREA DEFINED BETWEEN THE BOTTOM PLATE AND THE SUPPORTING LEGS.
 SEE MANUAL FOR ADDITIONAL INFORMATION



TITLE: 3PH DISTRIBUTION TRANSFORMER
 ENCLOSURE BOTTOM VIEW

				DES: PPLICASSI
				DATE: 18/06/05
NO.	DATE	BY	REVISION	SCALE: NTS

SHEET 3 OF 3

EDBTE3A0660JC