

ALL DIMENSIONS ARE IN INCHES
 * TOLERANCES STD. + / - 0.1 INCHES [+ / - 3 MM]

* OPTIONAL FUSEBLOCK ADAPTER KIT (P/N SPFBAK1) WILL ADD 0.38"[9.65] TO THE HEIGHT
 * OPTIONAL PRIMARY AND SECONDARY FINGERGUARDS (P/N SPFG1) WILL ADD 0.19"[4.9] TO THE HEIGHT AND 0.38"[9.65] TO THE DEPTH

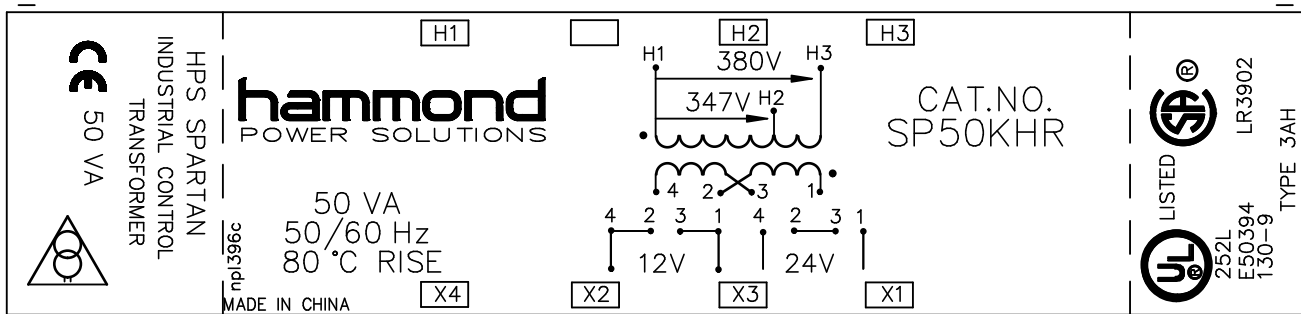

NOTES:



TITLE: SPARTAN 1 PHASE CONTROL TRANSFORMER

DES:	WWONG
DATE:	09/10/19
SCALE:	NTS

NO.	DATE	BY	REVISION

SHEET 1 OF 1

EDBSP50KHR

0.0 httpd 2026/06/25 01:01 THIS DRAWING CONTAINS STRICTLY CONFIDENTIAL INFORMATION BELONGING TO HAMMOND POWER SOLUTIONS AND MUST NOT BE DISTRIBUTED OUTSIDE AUTHORIZED PARTIES.