



TITLE: 3PH DISTRIBUTION TRANSFORMER  
NAMEPLATE INFORMATION

NO.	DATE	BY	REVISION

DES:	PPICASSI
DATE:	23/12/07
SCALE:	NTS

SHEET 1 OF 2

EDBFC2A0075PB

0.0 httpd 2026/06/25 05:28

THIS DRAWING CONTAINS STRICTLY CONFIDENTIAL INFORMATION BELONGING TO HAMMOND POWER SOLUTIONS AND MUST NOT BE DISTRIBUTED OUTSIDE AUTHORIZED PARTIES.



**hammond**  
POWER SOLUTIONS

Guelph, ONT Compton, CA Baraboo, WI Monterrey, MX

**HPS Fortress™ C**  
Dry Type Encapsulated Transformer  
Transformateur de Type Sec Encapsulé

Part No. FC2A0075PB



GENERAL PURPOSE TRANSFORMER 2521 E0394  
LISTED LR3902

Cust. Ref. Ref. du Client	Serial No. No. de Serie	HV/HT	600V	72.2A
Phase	3	BIL	10 kV	
Type	QT	Term Bornes	H1 H2 H3	
Cooling Refroidissement	ANC	LV/BT	208Y/120V	208A
kVA	75	BIL	10 kV	
Temp. Rise Echauffement	135 °C	Term Bornes	X0 X1 X2 X3	
Temp Class Classe Temp	220 °C	Winding Enroulement		
Frequency Fréquence Hz	60	Impedance % @ 155 °C		
Encl. Type Type De Coffrage	4	Weight Poids lbs/kg		1050/477

VOLTS	CURRENT COURANT	% RATED VOLTAGE % TENSION NOMINALE	CONNECTION EACH PHASE CONNECTION PAR PHASE
630	68.7	105	1
615	70.4	102.5	2
600	72.2	100	3
585	74.0	97.5	4
570	76.0	95	5
555	78.0	92.5	6
540	80.2	90	7

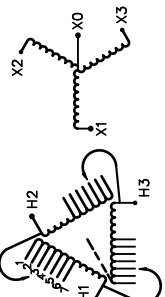

SPACINGS BETWEEN ANY VENTILATED ENCLOSURE PANEL AND ANY ADJACENT WALL SHALL BE A MINIMUM OF 3 INCHES ELECTROSTATIC SHIELD

d000200bqfc

FRONT VIEW

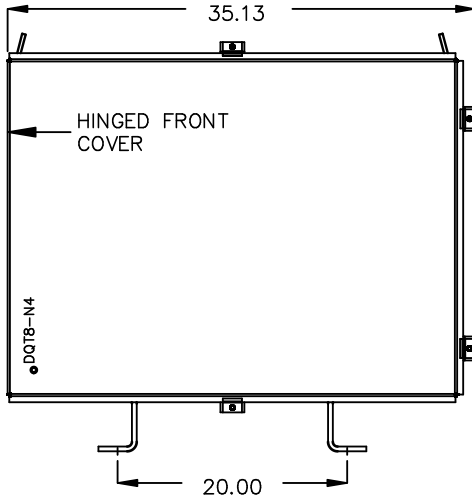

SIDE VIEW

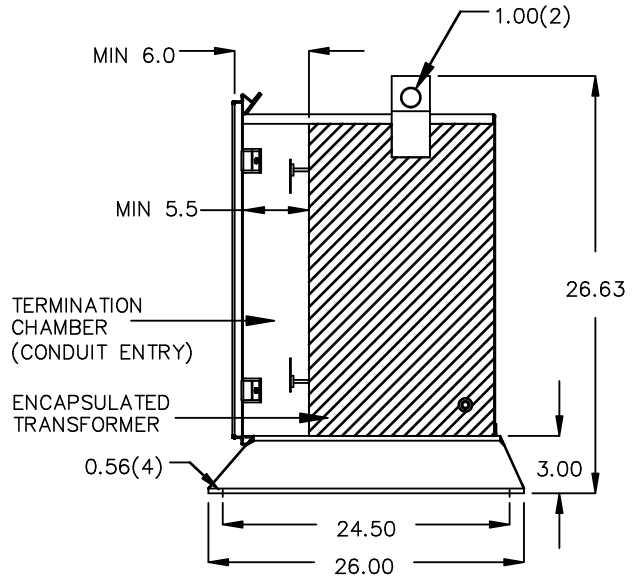

All Dimensions in inches

ENCLOSURE COLOR : ANSI 61 GREY – OUTDOOR

HV TERMINAL DETAIL

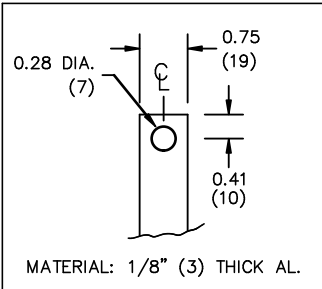

LV TERMINAL DETAIL

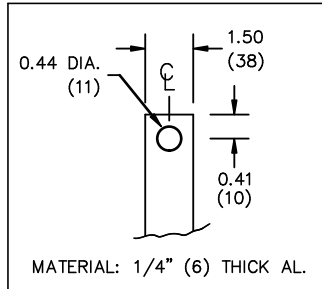

CUSTOMER NOTES:

- HV TERMINATED AT BOTTOM FRONT
- LV TERMINATED AT TOP FRONT



TITLE: 3PH DISTRIBUTION TRANSFORMER

DES:	PPICASSI
DATE:	23/12/07
SCALE:	NTS

NO.	DATE	BY	REVISION

SHEET 2 OF 2

EDBFC2A0075PB