



TITLE: 3PH DISTRIBUTION TRANSFORMER  
NAMEPLATE INFORMATION

NO.	DATE	BY	REVISION

DES:	PPICASSI
DATE:	23/12/07
SCALE:	NTS

SHEET 1 OF 2

EDBFC2A0030PB

0.0 httpd 2026/06/24 21:08

THIS DRAWING CONTAINS STRICTLY CONFIDENTIAL INFORMATION BELONGING TO HAMMOND POWER SOLUTIONS AND MUST NOT BE DISTRIBUTED OUTSIDE AUTHORIZED PARTIES.





**POWER SOLUTIONS**  
Guelph, ONT Compton, CA Baraboo, WI  
Monterrey, MX

**HPS Fortress™ C**  
Dry Type Encapsulated Transformer  
Transformateur de Type Sec Encapsulé

Part No. FC2A0030PB

  
 LISTED  
 LR3902

  
 GENERAL PURPOSE TRANSFORMER  
 2521  
 E30394



8 03423 19938 18

d000200bqfc

Cust. Ref. Ref. du Client	Serial No. No. de Serie	VOLTS	CURRENT COURANT	% RATED VOLTAGE % TENSION NOMINALE	CONNECTION EACH PHASE CONNECTION PAR PHASE
3	HV/HT	600V	27.5	105	1
QT	BIL	10 kV	28.2	102.5	2
ANC	Term Bornes	H1 H2 H3	28.9	100	3
30	LV/BT	208Y/120V 83.3A	29.6	97.5	4
135 °C	BIL	10 kV	30.4	95	5
220 °C	Term Bornes	X0 X1 X2 X3	31.2	92.5	6
AL			32.1	90	7
60					
1.9					
4					
474/216					

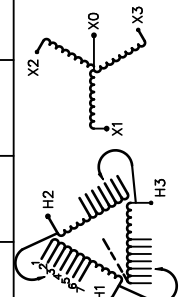

SPACINGS BETWEEN ANY VENTILATED ENCLOSURE PANEL AND ANY ADJACENT WALL SHALL BE A MINIMUM OF 3 INCHES ELECTROSTATIC SHIELD

FRONT VIEW

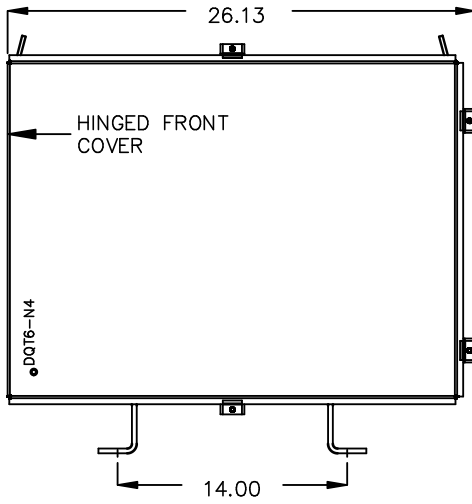

All Dimensions in inches

SIDE VIEW

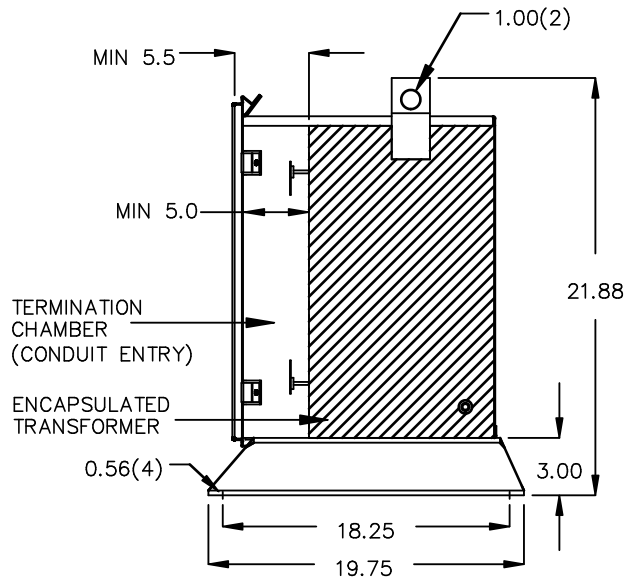

ENCLOSURE COLOR : ANSI 61 GREY – OUTDOOR

HV TERMINAL DETAIL

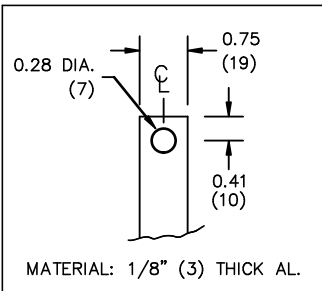

LV TERMINAL DETAIL

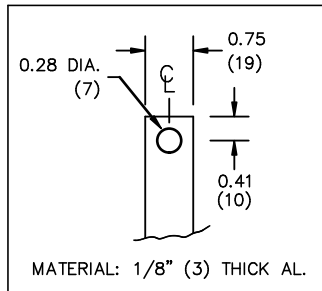

CUSTOMER NOTES:

- HV TERMINATED AT BOTTOM FRONT
- LV TERMINATED AT TOP FRONT



TITLE: 3PH DISTRIBUTION TRANSFORMER

DES:	PPICASSI
DATE:	23/12/07
SCALE:	NTS

NO.	DATE	BY	REVISION

SHEET 2 OF 2

EDBFC2A0030PB