



TITLE: 3PH FORTRESS C TRANSFORMER
NAMEPLATE INFORMATION

NO.	DATE	BY	REVISION

DES: PPI/CASSI
DATE: 23/12/01
SCALE: NTS

SHEET 1 OF 2

EDBFC2A0030KB

0.1 httpd 2026/06/21 20:52

THIS DRAWING CONTAINS STRICTLY CONFIDENTIAL INFORMATION BELONGING TO HAMMOND POWER SOLUTIONS AND MUST NOT BE DISTRIBUTED OUTSIDE AUTHORIZED PARTIES.



hammond
POWER SOLUTIONS

Guelph, ONT Compton, CA Baraboo, WI Monterrey, MX

HPS Fortress™ C
Dry Type Encapsulated Transformer
Transformateur de Type Sec Encapsulé

Part No. FC2A0030KB

GENERAL PURPOSE TRANSFORMER 8 03423 19937 11



LR3902 LISTED E0394



Cust. Ref. Ref. du Client	Serial No. No. de Serie	HV/HT	480V	36.1A
Phase	3			
Type	QT	BIL	10 kV	
Cooling Refroidissement	ANC	Term Bornes	H1 H2 H3	
kVA	30	LV/BT	208Y/120V	83.3A
Temp. Rise Echauffement	135 °C	BIL	10 kV	
Temp Class Classe Temp	220 °C	Term Bornes	X0 X1 X2 X3	
Winding Enroulement	AL			
Frequency Frequence Hz	60			
Impedance % @ 155 °C	1.9			
Encl. Type Type De Coffrage	4			
Weight Poids lbs/kg	463/211			

VOLTS	CURRENT COURANT	% RATED VOLTAGE % TENSION NOMINALE	CONNECTION EACH PHASE CONNECTION PAR PHASE
504	34.4	105	1
480	35.2	102.5	2
468	36.1	100	3
456	37.0	97.5	4
444	38.0	95	5
432	39.0	92.5	6
	40.1	90	7

SPACINGS BETWEEN ANY VENTILATED ENCLOSURE PANEL AND ANY ADJACENT WALL SHALL BE A MINIMUM OF 3 INCHES ELECTROSTATIC SHIELD

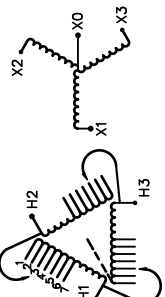

d000200bqfc

FRONT VIEW

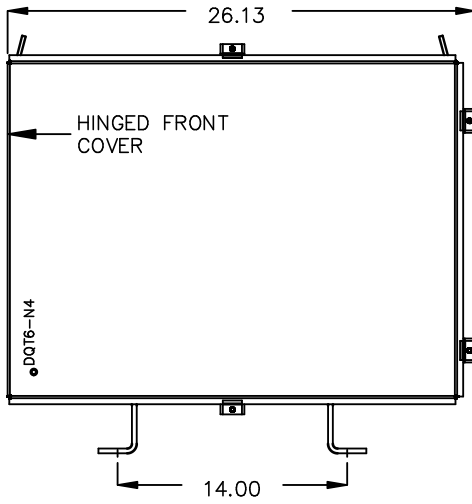

SIDE VIEW

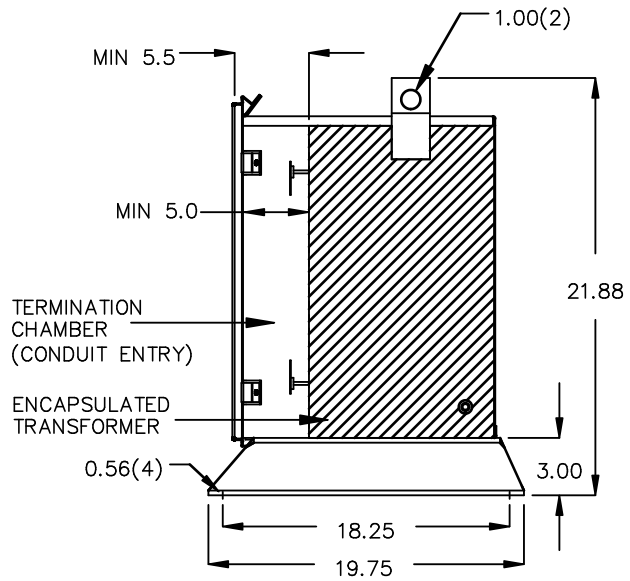

All Dimensions in inches

ENCLOSURE COLOR : ANSI 61 GREY – OUTDOOR

HV TERMINAL DETAIL

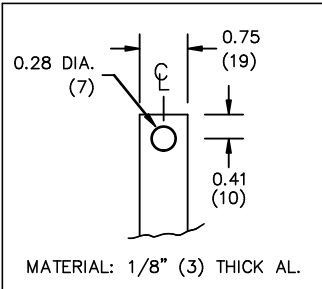

LV TERMINAL DETAIL

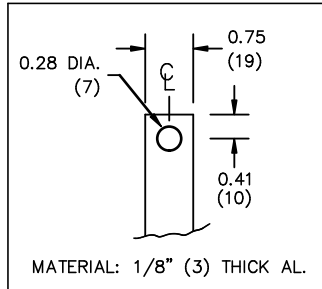

CUSTOMER NOTES:

- HV TERMINATED AT BOTTOM FRONT
- LV TERMINATED AT TOP FRONT



TITLE: 3PH FORTRESS C TRANSFORMER

DES:	PPICASSI
DATE:	23/12/01
SCALE:	NTS

NO.	DATE	BY	REVISION

SHEET 2 OF 2

EDBFC2A0030KB