



TITLE: 3PH ??? TRANSFORMER
NAMEPLATE INFORMATION

NO.	DATE	BY	REVISION	DES: PPICASSI
				DATE: 23/12/07
				SCALE: NTS

SHEET 1 OF 2

EDBFC2A0015KB

0.1 httpd 2026/04/04 16:02

THIS DRAWING CONTAINS STRICTLY CONFIDENTIAL INFORMATION BELONGING TO HAMMOND POWER SOLUTIONS AND MUST NOT BE DISTRIBUTED OUTSIDE AUTHORIZED PARTIES.



hammond
POWER SOLUTIONS

Guelph, ONT Compton, CA Baraboo, WI Monterrey, MX

HPS Fortress™ C
Dry Type Encapsulated Transformer
Transformateur de Type Sec Encapsulé

Part No. FC2A0015KB



GENERAL PURPOSE TRANSFORMER 2521 E30394
LISTED LR3902

Cust. Ref. Ref. du Client	Serial No. No. de Serie	HV/HT	480V	18.0A
Phase	3	BIL	10 kV	
Type	QT	Term Bornes	H1 H2 H3	
Cooling Refroidissement	ANC	LV/BT	208Y/120V	41.6A
kVA	15	BIL	10 kV	
Temp. Rise Echauffement	135 °C	Term Bornes	X0 X1 X2 X3	
Temp Class Classe Temp	220 °C	Winding Enroulement		
Frequency Frequence Hz	60	Impedance % @ 155 °C		
Encl. Type Type De Coffrage	4	Weight Poids	lbs/kg	316/144

VOLTS	CURRENT COURANT	% RATED VOLTAGE % TENSION NOMINALE	CONNECTION EACH PHASE CONNECTION PAR PHASE
504	17.2	105	1
480	17.6	102.5	2
468	18.0	100	3
456	18.5	97.5	4
444	19.0	95	5
432	19.5	92.5	6
	20.0	90	7

SPACINGS BETWEEN ANY VENTILATED ENCLOSURE PANEL AND ANY ADJACENT WALL SHALL BE A MINIMUM OF 3 INCHES ELECTROSTATIC SHIELD

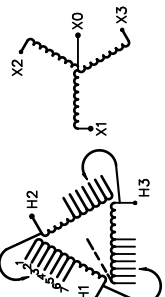

d000200bqfc

FRONT VIEW

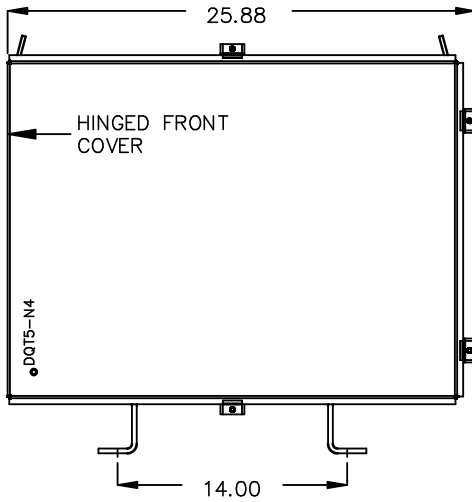

SIDE VIEW

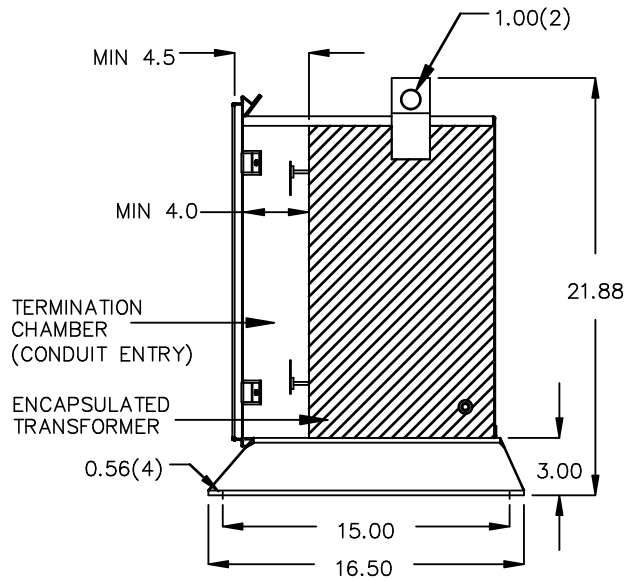

All Dimensions in inches

ENCLOSURE COLOR : ANSI 61 GREY – OUTDOOR

HV TERMINAL DETAIL

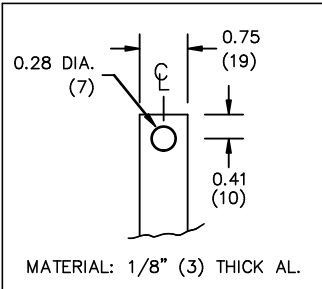

LV TERMINAL DETAIL

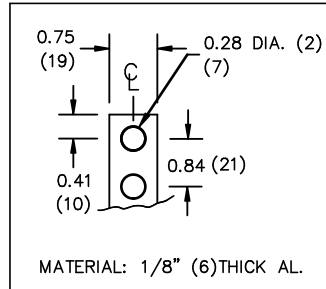

CUSTOMER NOTES:

- HV TERMINATED AT BOTTOM FRONT
- LV TERMINATED AT TOP FRONT



TITLE: 3PH ??? TRANSFORMER

DES:	PPICASSI
DATE:	23/12/07
SCALE:	NTS

NO.	DATE	BY	REVISION

SHEET 2 OF 2

EDBFC2A0015KB