

- IMPEDANCE SHOWN IS CALCULATED VALUE - NOT GUARANTEED

d000200bqfc

hammond
POWER SOLUTIONS

Guelph, ONT Baraboo, WI
Compton, CA Monterrey, MX

HPS Fortress™ C
Dry Type Encapsulated Transformer
Transformateur de Type Sec Encapsulé

Part No. FC2A0015BK



LR3902



LISTED

GENERAL PURPOSE TRANSFORMER 252L E0394

VOLTS	CURRENT COURANT	% RATED VOLTAGE % TENSION NOMINALE	CONNECTION EACH PHASE CONNECTION PAR PHASE
218	39.7	105	1
213	40.6	102.5	2
208	41.6	100	3
203	42.7	97.5	4
198	43.8	95	5
192	45.0	92.5	6
187	46.3	90	7

SPACINGS BETWEEN ANY VENTILATED ENCLOSURE PANEL AND ANY ADJACENT WALL SHALL BE A MINIMUM OF 3 INCHES ELECTROSTATIC SHIELD
TRANSFORMER SUITABLE FOR STEP UP OPERATION ONLY

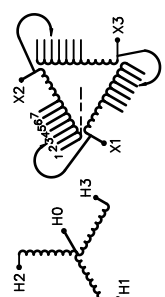



TITLE: 3PH DISTRIBUTION TRANSFORMER NAMEPLATE INFORMATION			
NO.	DATE	BY	REVISION

SHEET 1 OF 2

DES: RHARISH
DATE: 25/01/20
SCALE: NTS

EDBFC2A0015BK

FRONT VIEW

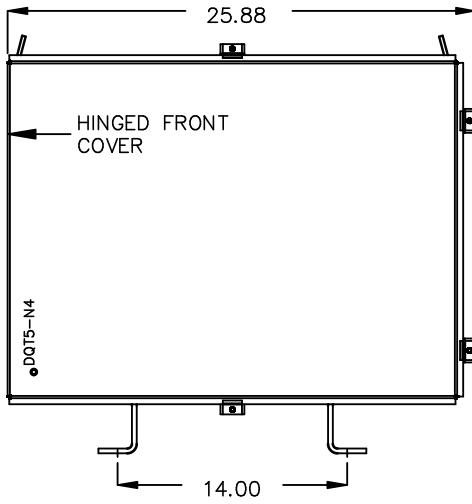

SIDE VIEW

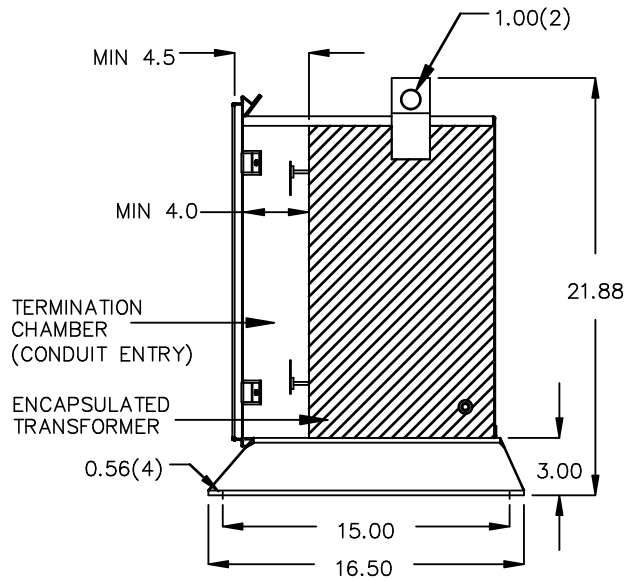

All Dimensions in inches

ENCLOSURE COLOR : ANSI 61 GREY – OUTDOOR

HV TERMINAL DETAIL

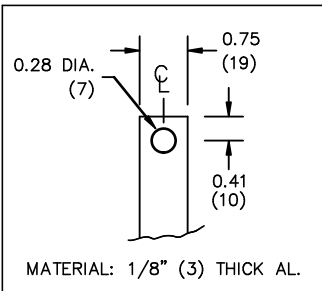

LV TERMINAL DETAIL

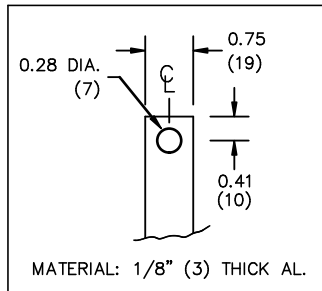

CUSTOMER NOTES:

- HV TERMINATED AT BOTTOM FRONT
- LV TERMINATED AT TOP FRONT



TITLE: 3PH DISTRIBUTION TRANSFORMER

DES:	RHARISH
DATE:	25/01/20
SCALE:	NTS

NO.	DATE	BY	REVISION

SHEET 2 OF 2

EDBFC2A0015BK

THIS DRAWING CONTAINS STRICTLY CONFIDENTIAL INFORMATION BELONGING TO HAMMOND POWER SOLUTIONS AND MUST NOT BE DISTRIBUTED OUTSIDE AUTHORIZED PARTIES. 0.0 httpd 2026/06/03 17:47