

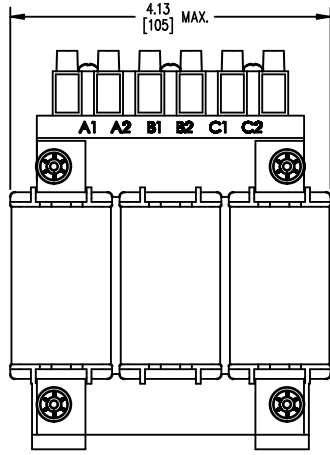

TOP VIEW

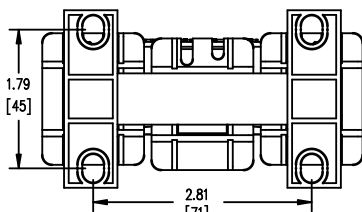

FRONT VIEW



BOTTOM VIEW

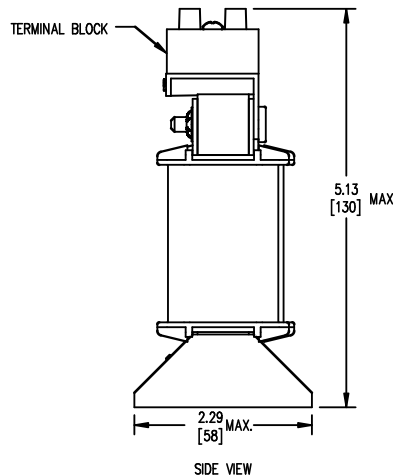

SIDE VIEW

TERMINAL BLOCK
SUITABLE FOR
#14 TO #18 AWG
CONDUCTORS
QTY. 1 PER PHASE

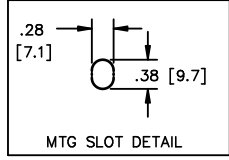

TOLERANCES
MOUNTING CENTERS = +/- .06"
MOUNTING HOLE SIZE = +/- .005"

THIS DRAWING CONTAINS PROPRIETARY INFORMATION
BELONGING TO HAMMOND POWER SOLUTIONS INC.,
AND IS NOT FOR GENERAL DISTRIBUTION

All Dimensions in Inches
mm in Parenthesis

REACTOR

hammond

POWER SOLUTIONS

HPS CENTURION R 3PH DRY TYPE REACTOR

CRX07D5AC

1.3MH 50/60 HZ 7.5 AMPS
0.6 KV CLASS TEMP CLASS: 130 TYPE JR-1
TERMINAL TORQUE: 5 LB-IN AMBIENT: 50°C

NOTES:



TITLE: 3 PHASE LINE REACTOR				DES: PBAKER DATE: 14/06/24 SCALE: NTS
NO.	DATE	BY	REVISION	

SHEET 1 OF 1
EDBCRX07D5AC

THIS DRAWING CONTAINS STRICKLY CONFIDENTIAL INFORMATION BELONGING TO HAMMOND POWER SOLUTIONS AND MUST NOT BE DISTRIBUTED OUTSIDE AUTHORIZED PARTIES.

0.1 htpd 2026/06/03 18:54