

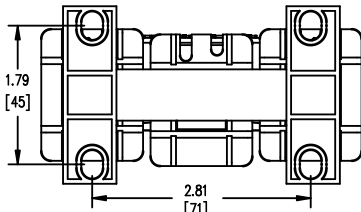

TOP VIEW



FRONT VIEW



BOTTOM VIEW



SIDE VIEW

TERMINAL BLOCK  
SUITABLE FOR  
#14 TO #18 AWG  
CONDUCTORS  
QTY. 1 PER PHASE



TOLERANCES  
MOUNTING CENTERS = +/- .06"  
MOUNTING HOLE SIZE = +/- .005"

THIS DRAWING CONTAINS PROPRIETARY INFORMATION  
BELONGING TO HAMMOND POWER SOLUTIONS INC.,  
AND IS NOT FOR GENERAL DISTRIBUTION

All Dimensions in Inches  
mm in Parenthesis

REACTOR

**hammond**  
POWER SOLUTIONS

HPS CENTURION R  
3PH DRY TYPE  
REACTOR

CRX06D1AC

4.7MH 50/60 HZ 6.1 AMPS

0.6 KV CLASS TEMP CLASS: 130 TYPE JR-1

TERMINAL TORQUE: 5 LB-IN AMBIENT: 50°C

NOTES:



TITLE: 3 PHASE LINE REACTOR

DES:	PBAKER
DATE:	14/06/24
SCALE:	NTS

NO.	DATE	BY	REVISION

SHEET 1 OF 1

EDBCRX06D1AC