



TITLE: IRON CORE LINE REACTOR
NAMEPLATE INFORMATION

NO.	DATE	BY	REVISION	DES: PBAKER
				DATE: 14/08/01
				SCALE: NTS

SHEET 1 OF 2

EDBCRX0472AE



hammond
POWER SOLUTIONS

HPS CENTURION R
3PH DRY TYPE
REACTOR

P/N CRX0472AE

INDUCT. 0.057 MH 50/60 HZ 472 AMPS

0.6 KV CLASS WT: 181 lbs ENCL. TYPE 1/IP20

AMBIENT: 50° TEMP CLASS: 220 TYPE JR-2A

USE WITH SUITABLY RATED LISTED (ZMWV) LUGS
WINDING TERMINAL TEMPERATURE: 75° C

MADE IN CANADA
f003783e



LR3902



IND. CONT. EQ. E61431
LISTED

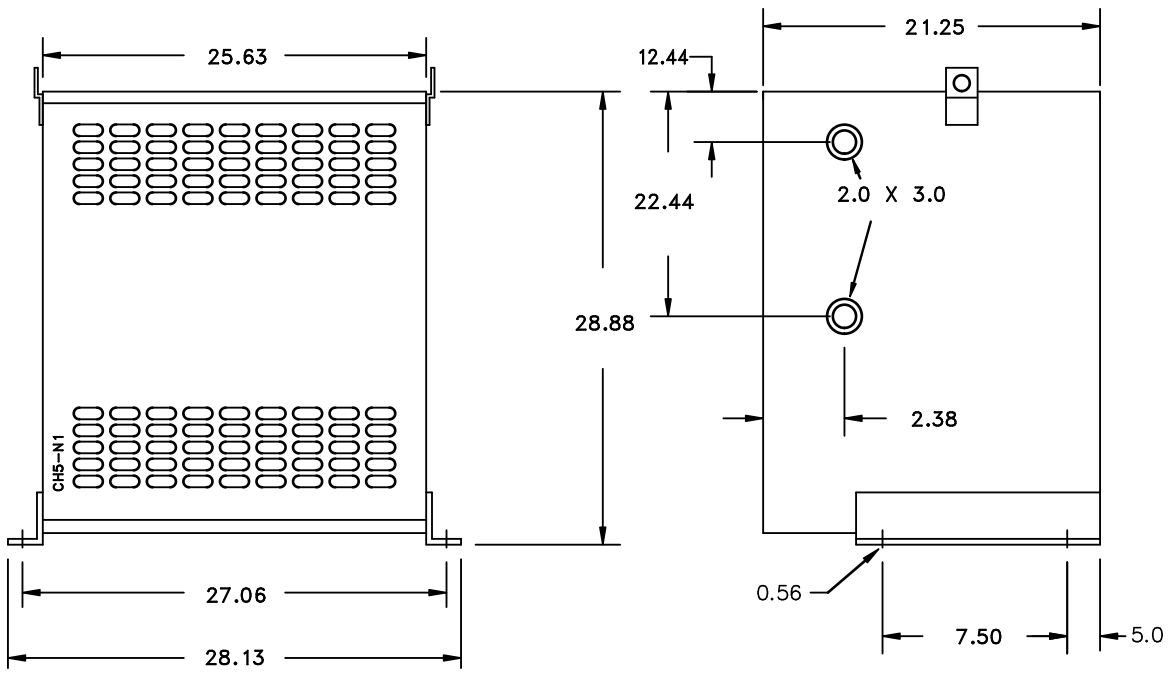

All Dimensions in inches

ENCLOSURE COLOR :ANSI 61 GREY – INDOOR

IN TERMINAL DETAIL

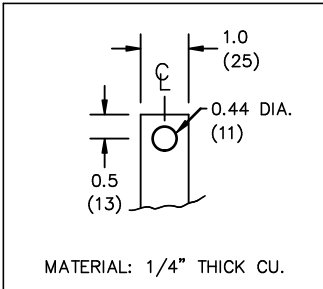

OUT TERMINAL DETAIL

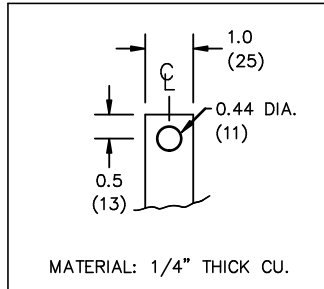

CUSTOMER NOTES:

- IN TERMINATED AT BOTTOM FRONT
- OUT TERMINATED AT TOP FRONT



TITLE: IRON CORE LINE REACTOR

DES:	PBAKER
DATE:	14/08/01
SCALE:	NTS

NO.	DATE	BY	REVISION

SHEET 2 OF 2

EDBCRX0472AE