

FRONT VIEW

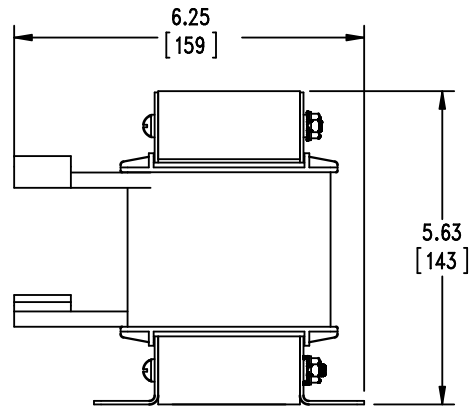

SIDE VIEW

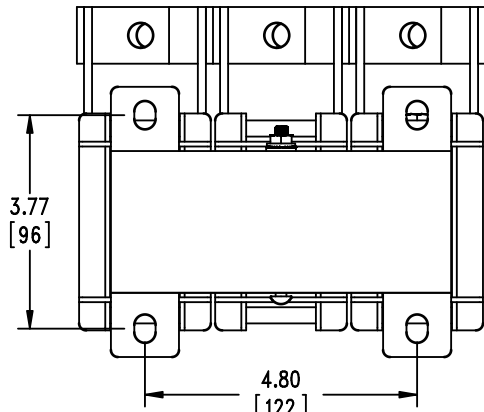

BOTTOM VIEW

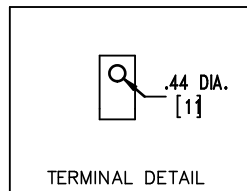

TERMINAL DETAIL

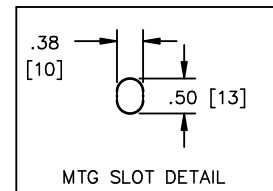

MTG SLOT DETAIL



TOLERANCES
MOUNTING CENTERS = +/- .06"
MOUNTING HOLE SIZE = +/- .005"

THIS DRAWING CONTAINS PROPRIETARY INFORMATION
BELONGING TO HAMMOND POWER SOLUTIONS INC.,
AND IS NOT FOR GENERAL DISTRIBUTION

All Dimensions in Inches
mm in Parenthesis

REACTOR



HPS CENTURION R
3PH DRY TYPE
REACTOR

MADE IN CANADA

P/N CRX0170AC

INDUCT. 0.058 mH Hz 50/60 AMPS 170 IP00

0.6 kV CLASS TEMP CLASS 180°C TYPE JR-3

WEIGHT 23 (LBS/KG) AMBIENT: 50°C

USE WITH SUITABLY RATED LISTED (ZMVV) LUGS

WINDING TERMINAL TEMPERATURE: 75° C



LR3902



10037760e

NOTES:



TITLE: IRON CORE LINE REACTOR

DES:	PBAKER
DATE:	14/07/04
SCALE:	NTS

NO.	DATE	BY	REVISION

SHEET 1 OF 1

EDBCRX0170AC