

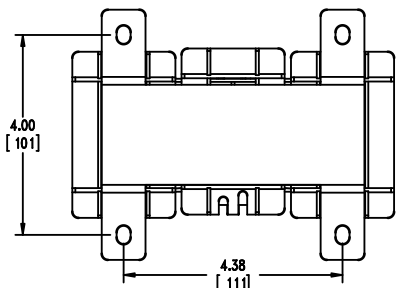

TOP VIEW



FRONT VIEW



BOTTOM VIEW

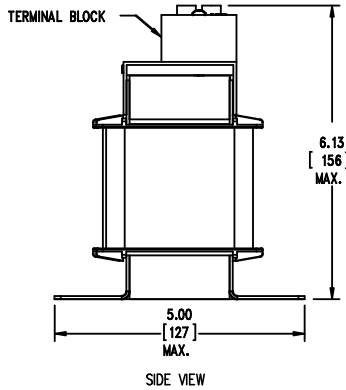

SIDE VIEW

TERMINAL BLOCK
SUITABLE FOR
#14 TO #4 AWG
CONDUCTORS
QTY. 1 PER PHASE

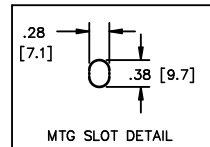

MTG SLOT DETAIL



TOLERANCES
MOUNTING CENTERS = +/- .06"
MOUNTING HOLE SIZE = +/- .005"

THIS DRAWING CONTAINS PROPRIETARY INFORMATION
BELONGING TO HAMMOND POWER SOLUTIONS INC.,
AND IS NOT FOR GENERAL DISTRIBUTION

All Dimensions in Inches
mm in Parenthesis

REACTOR

hammond
POWER SOLUTIONS

HPS CENTURION R
3PH DRY TYPE
REACTOR

CRX0021AC

1.1MH 50/60 HZ 21 AMPS

0.6 KV CLASS TEMP CLASS: 130 TYPE JR-1

TERMINAL TORQUE: 11 LB-IN AMBIENT: 50°C

NOTES:



TITLE: 3 PHASE LINE REACTOR

DES:	PBAKER
DATE:	14/06/24
SCALE:	NTS

NO.	DATE	BY	REVISION

SHEET 1 OF 1

EDBCRX0021AC